

# Specification

## YS-M98V

Intelligent Terminal

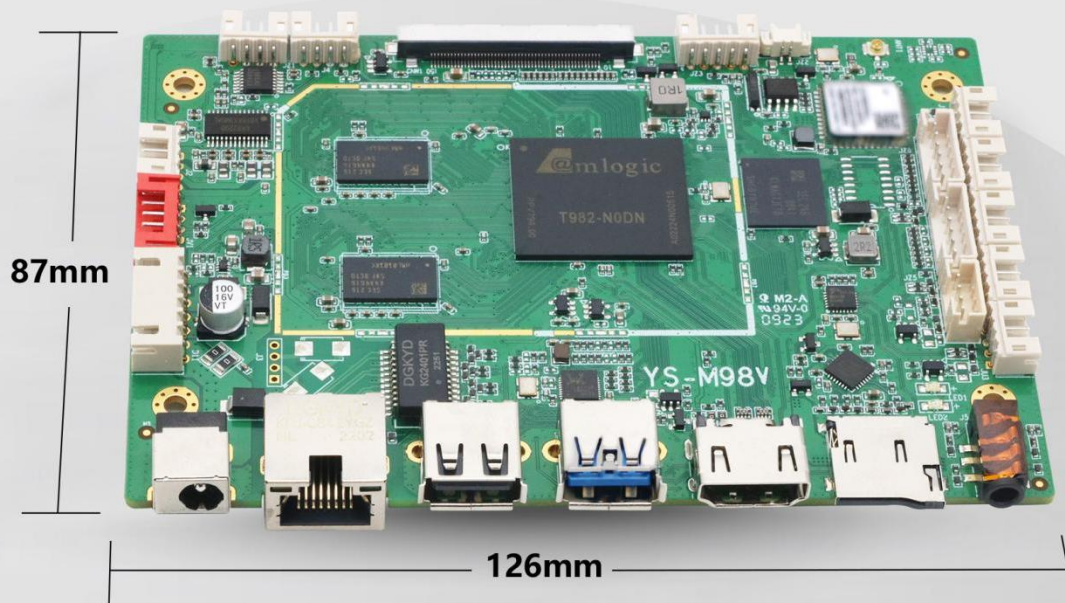

# Contents

<b>Declaration</b> .....	1
<b>Revision History</b> .....	1
<b>Chapter 1 Product Introduction</b> .....	2
1.1 Overview.....	2
1.2 Pictures and Dimensions.....	2
1.3 Product Detailed Parameters.....	4
1.4 Configuration & General Precautions.....	5
<b>Chapter 2 Interface Pin Name</b> .....	6
Chapter 3 Electrical Characteristics.....	10
<b>Chapter 4 System Instruction</b> .....	11
4.1 Android System Interface Description.....	11
4.2 Network Interface Explanation.....	12
4.3 Viewing Storage and Memory.....	14
4.4 Setting The Notification Bar And Navigation Bar.....	15
<b>Chapter 5 Contact Us</b> .....	16

# Declaration

Images and specifications mentioned in this document are for reference only. Any further changes or updates will not be sent to you unless special contract signed. This document serves as a product guide and the statements made in it do not constitute any form of guarantee. Without the written permission of Yisheng Technology Co., Ltd., no individual or organization may reproduce any part of this document or engage in any form of dissemination for profit. In order to obtain the latest version of product information, please visit Yisheng Technology Co., Ltd.'s official website regularly or contact company staff for assistance. Thank you for your understanding and support!

# Revision History

Version	Date	Author	Approver	Description
V1.0	2023.02.28	Zhang Wenjuan	Qin Yongling	Initial version
V1.3	2024.01.10	Zhang Wenjuan	Qin Yongling	Change motherboard picture
V1.4	2024.10.22	Zhang Wenjuan	Li Quan	Change Wifi module picture
V1.5	2024.11.6	Zhang Wenjuan	Li Quan	Correct BT version

# Chapter 1 Product Introduction

## 1.1 Overview



YS-M98V belongs to the intelligent Android motherboard, with rich control interface and extension interface, perfect support for the message system, support for remote production, release, management and real-time update program, support for local/network timing switch; Equipped with industrial binocular camera and face recognition technology, as well as infrared human body temperature measurement module; It is an efficient, safe and highly reliable product.

The product has a wide range of applications in intelligent display terminal, industrial automation terminal and video terminal. Such as: digital signage, intelligent self-service terminal, new retail intelligent terminal, intelligent display, building intercom, etc.

## 1.2 Pictures and Dimensions

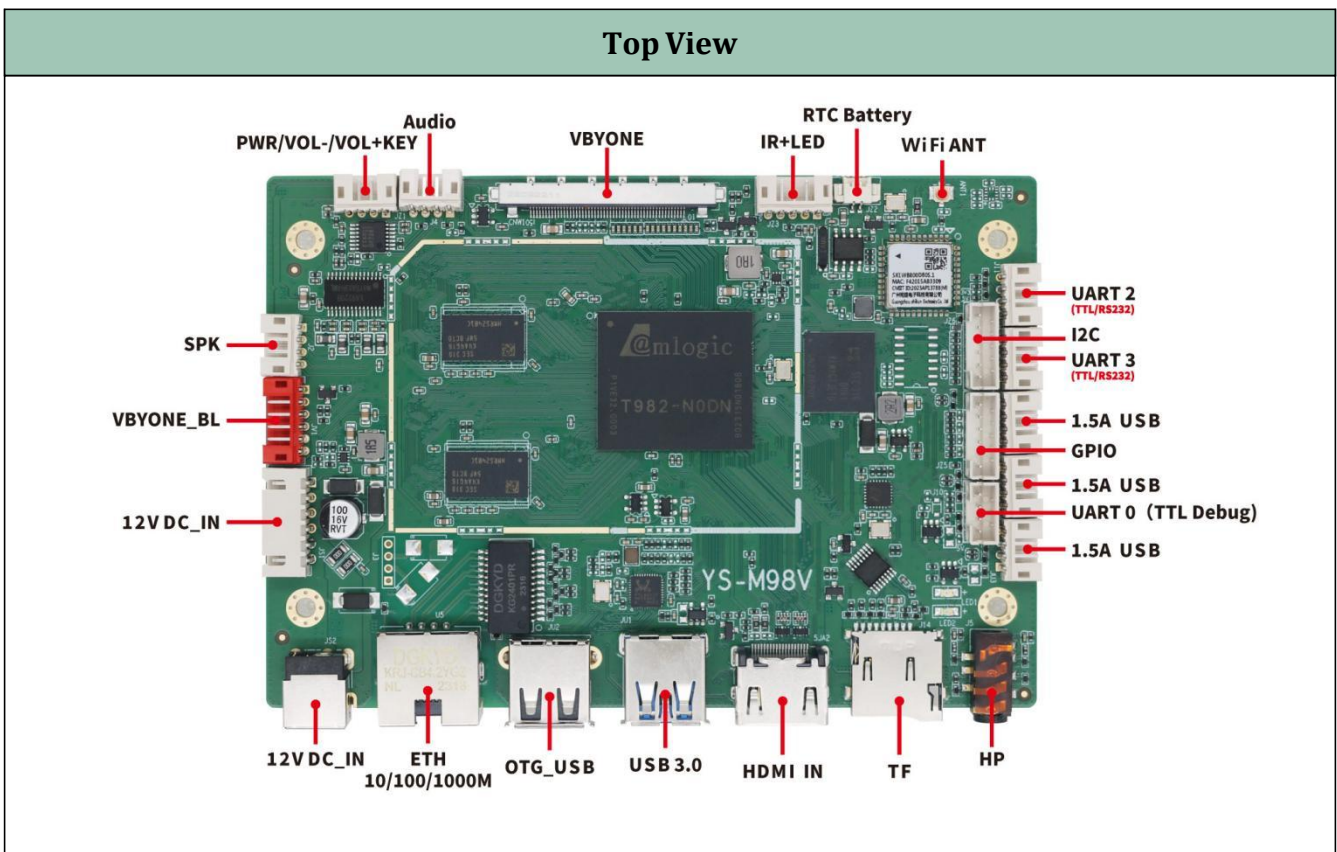

Bottom View

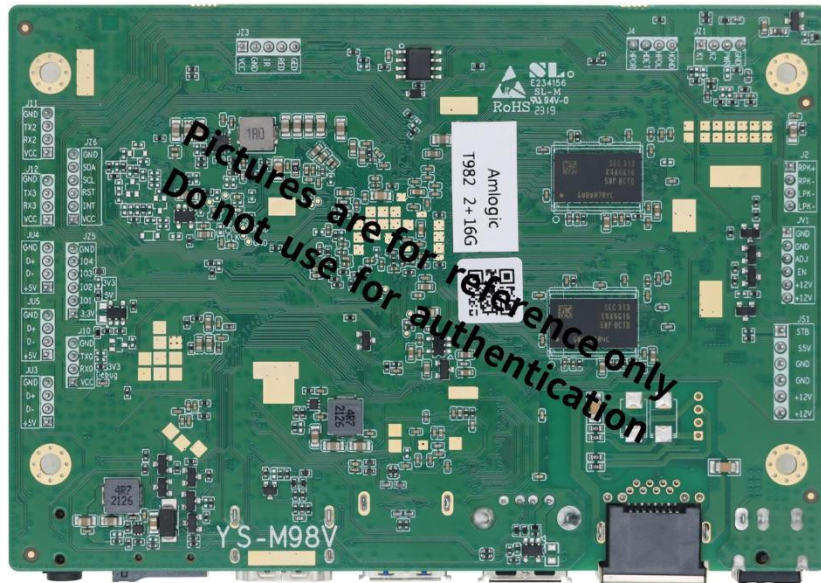

Dimensions

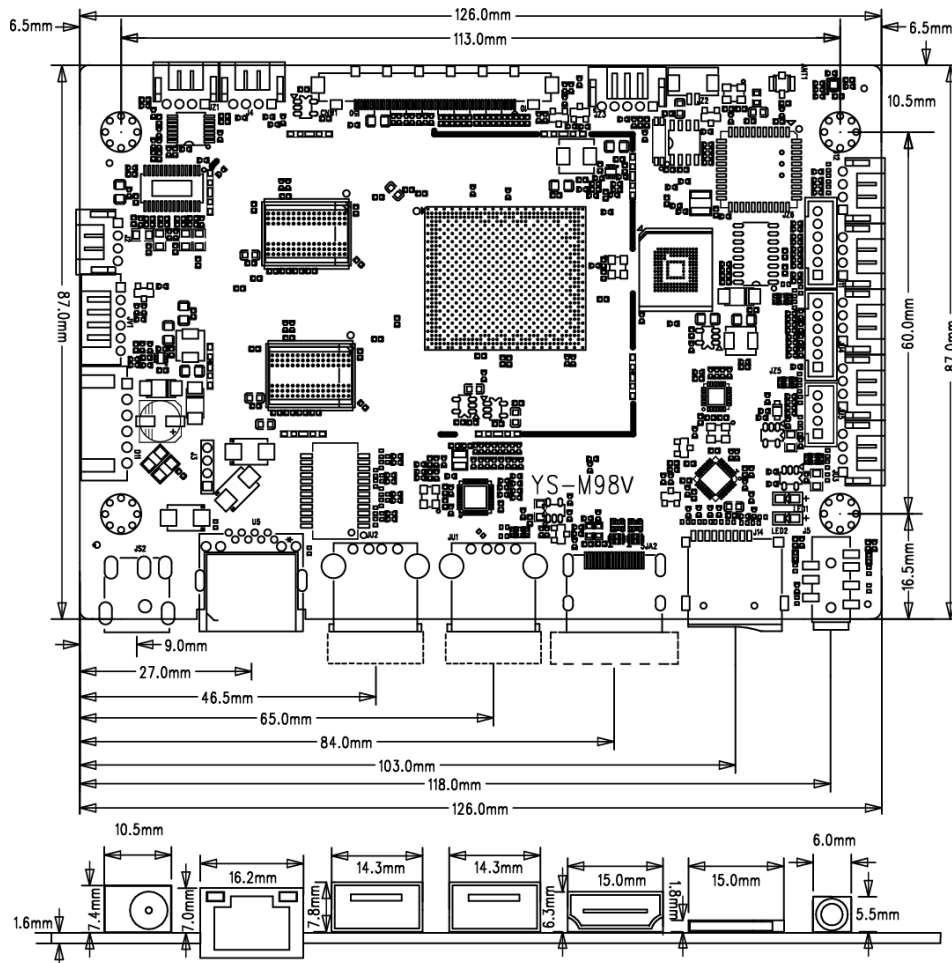

\*PCBA L: 126mm

\*PCBA W: 87mm

\*PCBA H: 12mm

\*PCBA Location Hole:  $\Phi 3.2\text{mm} \times 4$

## 1.3 Product Detailed Parameters



### Detail Specification

<b>SOC</b>	Amlogic T982
<b>CPU</b>	Quad-core Cortex-A55 Main frequency up to 1.92GHz
<b>GPU</b>	Mali-G52 MP2 (2EE) OpenGL ES 3.2 OpenCL 2.0 Vulkan 1.1
<b>NPU</b>	2 NNA with INT8 inference performance up to 2.6 TOPS
<b>OS</b>	<b>Android:</b> Android 11.0
<b>Video CODEC</b>	<p><b>Video Decoder</b></p> <p>8Kx4K@30fps or 4Kx2K@60fps: AV1 MP-10, H.265 HEVC MP-10, VP9 4Kx2K@60fps: AVS2 MP 4Kx2K@30fps: H.264 AVC 1080P@60fps: MPEG-4/2/1, WMV/VC-1, AVS-P16</p> <p>Supports *.mkv, *.wmv, *.mpg, *.mpeg, *.dat, *.avi, *.mov, *.iso, *.mp4 and *.jpg file formats</p> <p><b>Video Encoder</b></p> <p>1080P@30fps: H.264</p>
<b>ROM</b>	2/4GB (Up to 8GB) DDR
<b>Storage</b>	16/32/64GB (Up to 128GB) EMMC
<b>Display Output</b>	1*VBYONE (Up to 4K@60HZ)
<b>Display Input</b>	1*HDMI 2.0 (4K@60HZ)
<b>Audio</b>	1*SPK (L&R audio-out, Up to 1*8Ω/5W speaker) 1*HP (CTIA) 1*Audio
<b>Network</b>	Ethernet: Support 10/100/1000M GMAC WIFI: Support dual-band WIFI6 Bluetooth: 5.4
<b>USB</b>	1*Type-A USB3.0 HOST 1*Type-A USB2.0 (OTG or HOST) 3*USB2.0 HOST (4Pin*2.0mm Wafer)

UART	4*TTL(2*TTL,2* TTL/RS232)
Other	1*I2C 4*GPIO 1*IR+LED 3*Key (1*PWR_Key,2*Vol_Key)

## 1.4 Configuration & General Precautions

1. Relative humidity  $\leq 85\%$
2. Storage temperature:  $-30\text{ }^{\circ}\text{C}$  to  $+70\text{ }^{\circ}\text{C}$
3. Operating temperature:  $-15\text{ }^{\circ}\text{C}$  to  $+60\text{ }^{\circ}\text{C}$
4. During the assembly of the whole machine, please do not operate the wiring with power to avoid short circuit between bare board and peripheral equipment.
5. Pay attention to the anti-static treatment during the assembly and transportation of the whole machine, and it is necessary to wear electrostatic protection tools such as electrostatic bracelet (sleeve).
6. When assembling the whole machine, it can be installed at the bottom or side, but do not deform or twist the board, and do not bear heavy pressure.
7. Proper distance shall be reserved at the wiring position of each terminal to avoid squeezing the terminal during installation.
8. The connecting line between this board and the supporting module board should not be too long, otherwise it may affect the image quality.
9. The internal wiring of the whole machine shall be reasonable, and the connecting wires shall not pass through the PCB board directly as far as possible.
10. In order to achieve better EMC effect for the whole machine, it is recommended that the screen wire between the main board and the screen should be shielded wire.
11. The specifications of the peripherals connected to the installation shall be confirmed with our company, including but not limited to: voltage limit, current limit, timing, power domain, etc.

## Chapter 2 Interface Pin Name

### D11 (6PIN/2.54) 12V DC\_IN

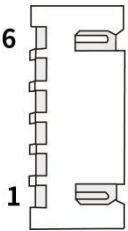
Exterior	Pin No.	Pin Name	Description
	1	STB	Power supply enable, connect to PSON
	2	S5V	5V constant power supply (standby)
	3	GND	Ground
	4	GND	Ground
	5	+12V	12V Power Input
	6	+12V	12V Power Input

### JV1 (6PIN/2.0) VBYONE\_BL

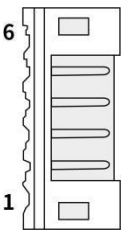
Exterior	Pin No.	Pin Name	Description
	1	GND	Ground
	2	GND	Ground
	3	ADJ	Backlight Brightness Adjustment
	4	EN	Backlight On/Off Control
	5	+12V	Screen Backlight Power Supply
	6	+12V	Screen Backlight Power Supply

### J2 (4PIN/2.0) SPK

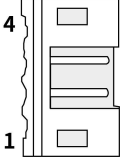
Exterior	Pin No.	Pin Name	Description
	1	RPK+	Positive output for right Channel
	2	RPK-	Negative output for right Channel
	3	LPK-	Negative output for left Channel
	4	LPK+	Positive output for left Channel

### JZ1 (4PIN/2.0) PWR/VOL-/VOL+ Key

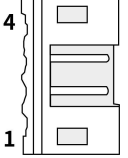
Exterior	Pin No.	Pin Name	Description
	1	K1	Volume up
	2	K2	Volume down
	3	PWR	Power on/off
	4	GND	GROUND

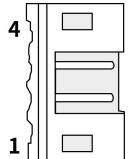

**J4 (4PIN/2.0) Audio**

Exterior	Pin No.	Pin Name	Description
	1	HPOL	Left Channel
	2	HDET	Test
	3	HPOR	Right Channel
	4	HGND	Ground

**CW1 V-BY-ONE (51PIN/0.5mm)**

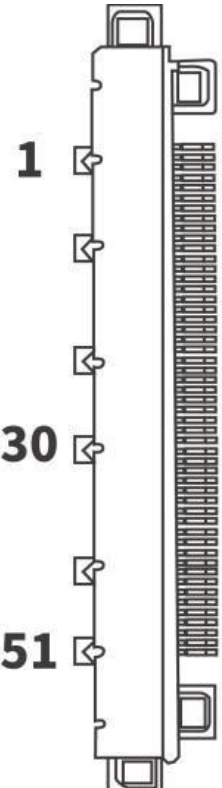
Exterior	Pin No.	Pin Name	Description
	1	GND	Ground
	2	VBX1_7P	VBYONE Signal
	3	VBX1_7N	VBYONE Signal
	4	GND	Ground
	5	VBX1_6P	VBYONE Signal
	6	VBX1_6N	VBYONE Signal
	7	GND	Ground
	8	VBX1_5P	VBYONE Signal
	9	VBX1_5N	VBYONE Signal
	10	GND	Ground
	11	VBX1_4P	VBYONE Signal
	12	VBX1_4N	VBYONE Signal
	13	GND	Ground
	14	VBX1_3P	VBYONE Signal
	15	VBX1_3N	VBYONE Signal
	16	GND	Ground
	17	VBX1_2P	VBYONE Signal
	18	VBX1_2N	VBYONE Signal
	19	GND	Ground
	20	VBX1_1P	VBYONE Signal
	21	VBX1_1N	VBYONE Signal
	22	GND	Ground
	23	VBX1_0P	VBYONE Signal
	24	VBX1_0N	VBYONE Signal
	25	GND	Ground
	26	LOCKN-OUT	Control Signal
	27	HTPDN	Control Signal
	28	SEL-LVDS	Control Signal
	29	AGP	Control Signal
	30	SCN-EN	Control Signal

	31	Bit-SEL1	Control Signal
	32	LD-EN2	Control Signal
	33	BOE-SCL	IIC Signal
	34	BOE-SDA	IIC Signal
	35	2D/3D	Control Signal
	36	L/R-IN	Control Signal
	37	L/R-OUT	Control Signal
	38	NC	Null
	39	GND	Ground
	40	GND	Ground
	41	GND	Ground
	42	GND	Ground
	43	NC	Null
	44-50	VCC	12V Power Supply
	51	VCC-VX1	12V Power Supply

**JZ3 (5PIN/2.0) IR+LED**

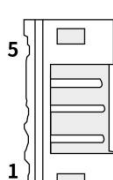
Exterior	Pin No.	Pin Name	Description
	1	VCC	3.3V Power Supply
	2	GND	Ground
	3	IR	Remote Control Infrared
	4	RED	Red Light
	5	GED	Green light

**JZ2 (2PIN/2.0) RTC Battery**

Exterior	Pin No.	Pin Name	Description
	1	BAT+	Battery Positive
	2	BAT-	Battery Negative

**JZ6 (6PIN/2.0) IIC(Power domain 3.3V)**

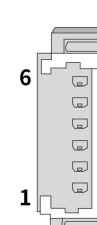
Exterior	Pin No.	Pin Name	Description
	1	3.3V	Power Supply
	2	INT	Interrupt
	3	RST	Reset
	4	SCL	12C Clock
	5	SDA	12C Data
	6	GND	Ground

**JZ5 (6PIN/2.0) GPIO (Power domain 3.3V)**

Exterior	Pin No.	Pin Name	Description
	1	3.3V	Power Supply
	2	IO1	GPIO1
	3	IO2	GPIO2
	4	IO3	GPIO3
	5	IO4	GPIO4
	6	GND	Ground

**J10 (4PIN/2.0) TTL UART 0 (Debug) (Power domain 3.3V)**

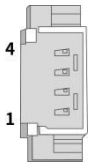
Exterior	Pin No.	Pin Name	Description
	1	VCC	Power 3.3V
	2	RX0	UART Receive
	3	TX0	UART Transmit
	4	GND	Ground

**J12 (4PIN/2.0) UART 2 (TTL/RS232, TTL power domain is 3.3V)**

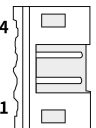
Exterior	Pin No.	Pin Name	Description
	1	VCC	Power 5V (Can optional 3.3v)
	2	RX2	UART Receive
	3	TX2	UART Transmit
	4	GND	Ground

**J11 (4PIN/2.0) UART 3 (TTL/RS232, TTL power domain is 3.3V)**

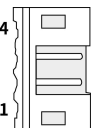
Exterior	Pin No.	Pin Name	Description
	1	VCC	Power 5V (Can optional 3.3v)
	2	RX3	UART Receive
	3	TX3	UART Transmit
	4	GND	Ground

**JU4、JU5、JU3 (4PIN/2.0) USB (JU5 is the main control directly control USB)**

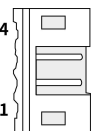
Exterior	Pin No.	Pin Name	Description
	1	+5V	USB Power Supply
	2	D-	USB data-
	3	D+	USB data+
	4	GND	Ground

## Chapter 3 Electrical Characteristics

### ◆ Normal Operating Conditions

Interface Type		Min	Typ	Max
Standard power parameters	Vcc	11V	12V	13.5V
	Ripple	/	/	60mV
	Current	2A	3A	/

### ◆ Power Consumption

Interface Type		Min	Typ	Max
Power Supply Current (with no display connected )	Operation Current	/	250mA	400mA
	STAND-BY CURRENT	/	25mA	30mA
	BATTERY OPERATION CURRENT	/	0.0024mA	/

### ◆ USB Power Supply

USB Interface Type	Voltage	Typical Current	Max Current
OTG_USB	5V	500mA	1.5mA
HOST_USB	5V	500mA	1.5mA

Note: It is recommended that the total current of USB peripherals not exceed 3000mA; otherwise, the machine cannot operate normally.

### ◆ Other

Interface Type	Rated Current	Typical Current	Max Current
EXT 5V	/	/	3000mA
EXT 3.3V	/	/	3000mA

## Chapter 4 System Instruction

### 4.1 Android System Interface Description

The main menu interface of Android system is divided into four categories: application, settings, file management and browser.

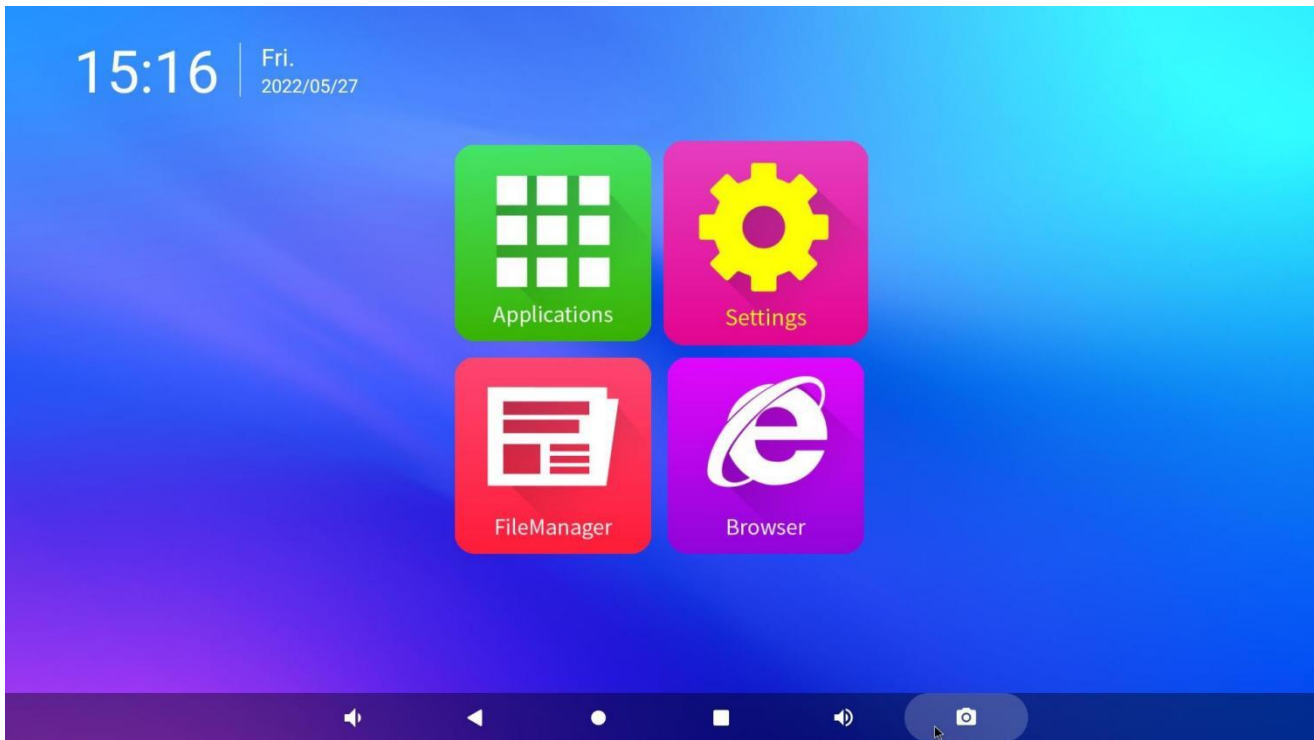

Homepage

#### (1) Application interface

The application interface includes: Power on / off, settings, gallery, file, camera, music, explorer, browser, HDMI-IN, etc.

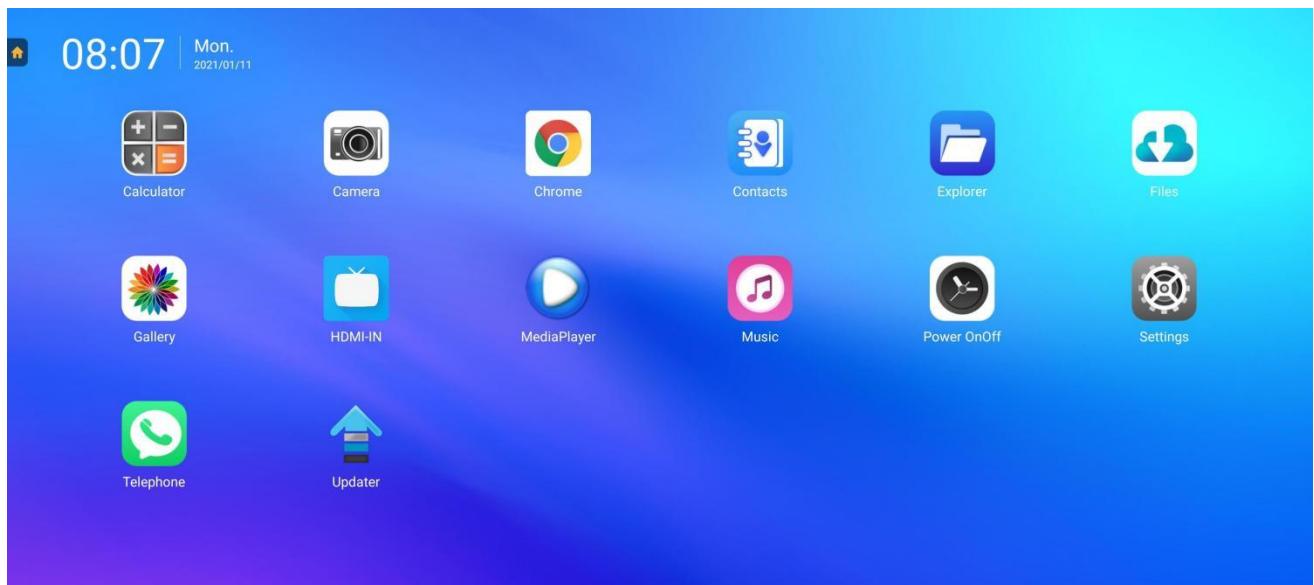

Application Interface

### (2) File Management Interface

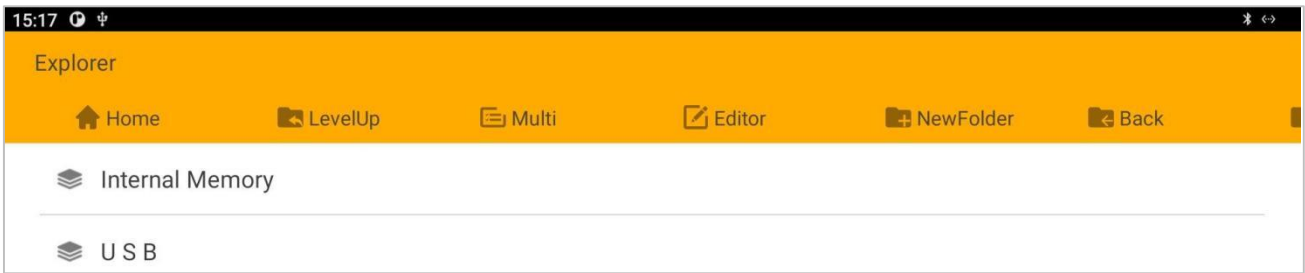

File Management Interface

### (3) Setting Menu Interface

It supports the settings of wireless network and device display sound, and can also view the program applications installed on the device, storage memory, etc.

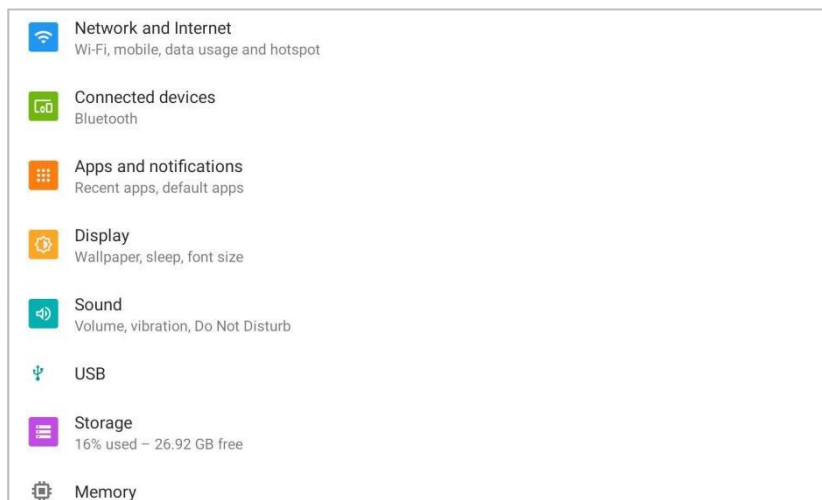

Setting Menu Interface

## 4.2 Network Interface Explanation

### (1) WIFI Network Signal Connection

Turn on the WiFi switch in the "setting" interface, as shown in the following figure; Select the WiFi signal to be connected and enter the corresponding password to successfully connect.

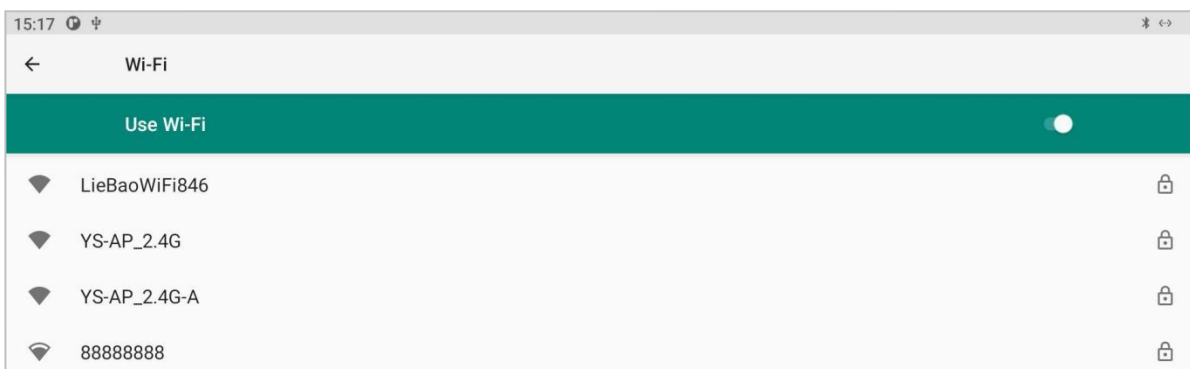

WIFI Setting Interface

### (2) WiFi Hotspot

As shown in the following figure, in the "Settings - network and Internet" interface, open the "hotspot and network sharing - WIFI hotspot" function, enter the interface shown in the figure below, you can send WiFi signals, and the device can successfully connect to the hotspot by entering the password.

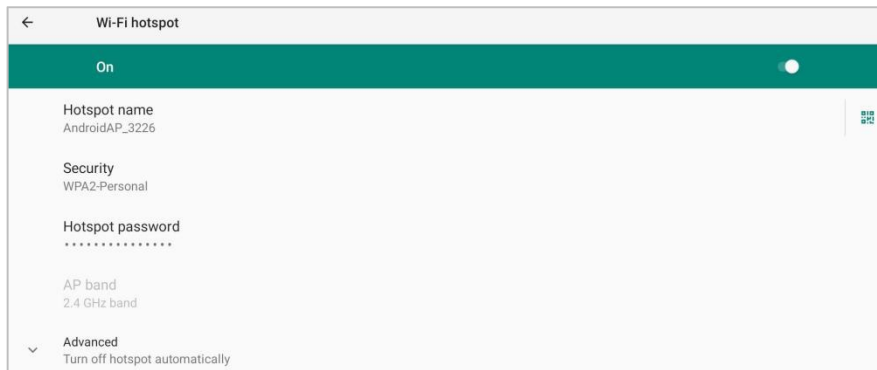

WiFi Hotspot connection interface

### (3) Bluetooth Signal Connection

In the "Settings" interface, open the "connected devices" function and enter the "pairing with new devices" interface shown in the figure below to search for Bluetooth devices and pair them.



Bluetooth Setting Interface

### (4) Ethernet Connection

In the "Settings" interface, enter "network and Internet", turn on Ethernet, enter the page shown in the figure below, turn on the Ethernet switch, then plug in the network cable and automatically connect to Ethernet. You can view the IP address, Ethernet MAC address and other information in the interface shown in the figure below.

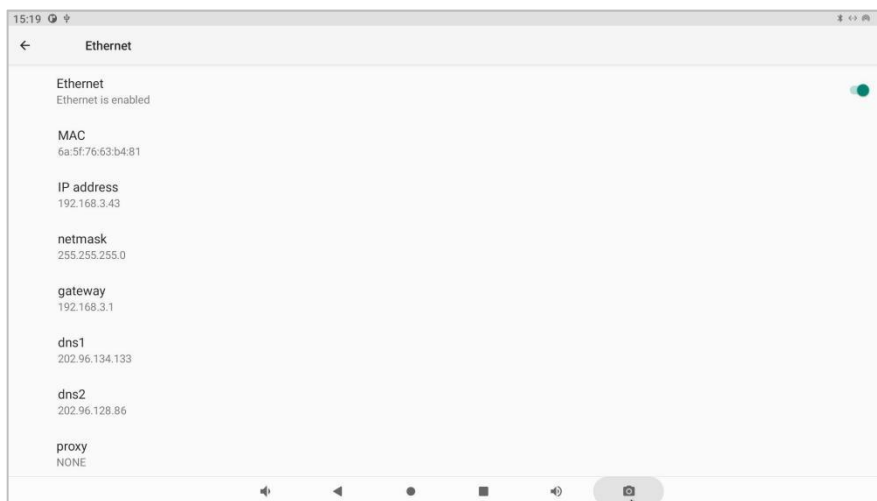

Ethernet Setting Interface

**Notice:**

- The use of the wireless network must be connected to the WIFI antenna at the WIFI antenna holder
- The availability and coverage of WIFI signals depends on the number of signals, antenna performance and external environment.
- The Ethernet MAC address is the only permanent and valid device ID for this system.

The network priority order for all Android devices is:

1. ETH Ethernet network
2. WIFI wireless network
3. 3G/4G/5G mobile network

### 4.3 Viewing Storage and Memory

In settings, select "storage" to enter the following interface, where the storage information of the storage space will be displayed. The display of 5.08GB capacity is the remaining available storage capacity of the board, and the display of "Total used 32.00GB" is the total storage capacity of the hardware.

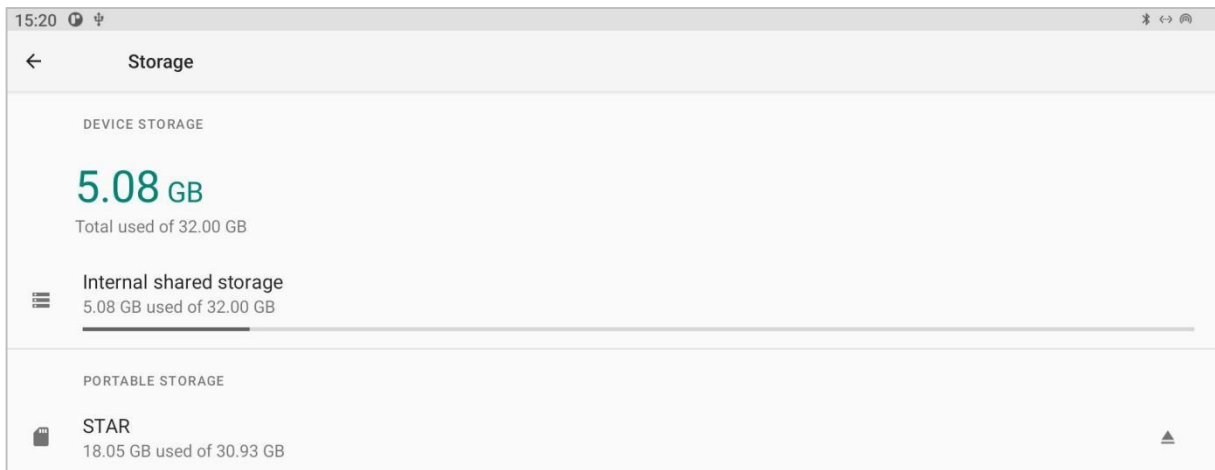

Viewing Storage Interface

In the setting, select "memory" to enter the interface below to display the built-in storage information. The display shows that the capacity of 1.6GB is the remaining memory capacity of the board, and the display of "total memory 2GB" is the total memory.

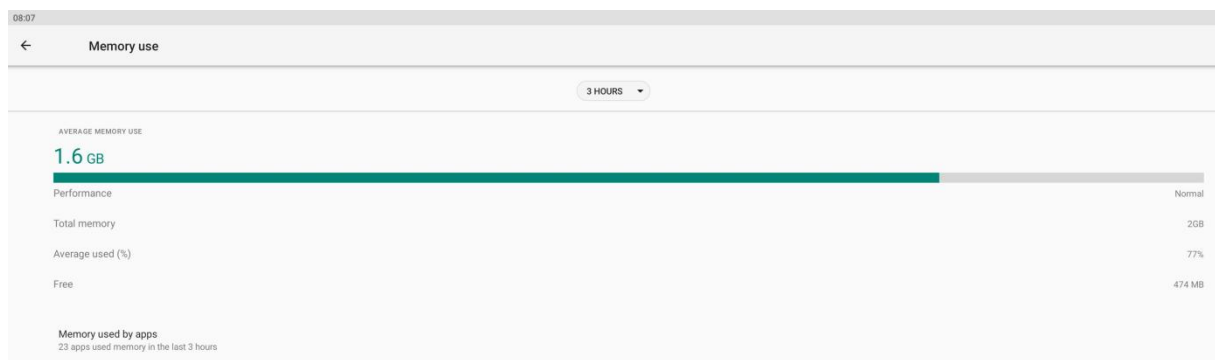

View Memory Interface



## 4.4 Setting The Notification Bar And Navigation Bar

In the setting, select "display": check "hide navigation bar", and the navigation bar will be hidden; Check "swipe navigation bar", and the navigation bar can be slid out by sliding the mouse up from the bottom. The navigation bar will disappear 5 seconds after no operation. If disable expand statusbar is checked, expand statusbar cannot be pulled down; Check "hide top statusbar" to hide the top statusbar showing time and other statuses at the top of the interface.

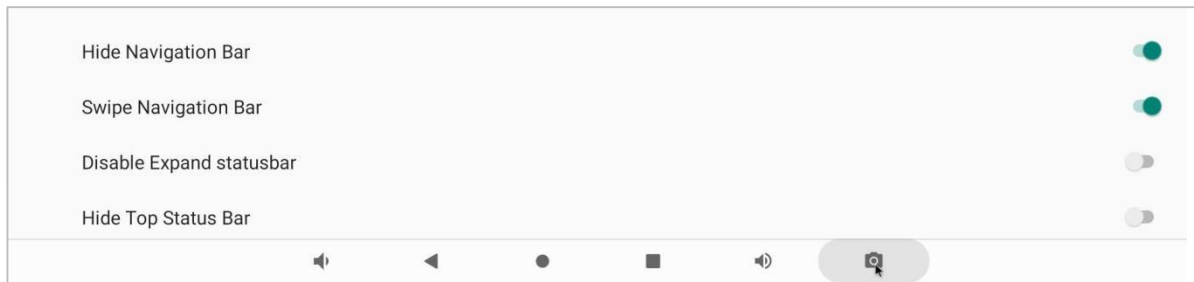

Navigation Bar

**NOTE:**

"Hide navigation bar" must be selected before "swipe navigation bar" is selected;

When hide top statusbar is selected, expand statusbar is also forced to be hidden by default.

## Chapter 5 Contact Us



**Contact Information:**

**Tel:** 0755-27383670

**Email:** [lisiping@yishengtc.com](mailto:lisiping@yishengtc.com)

**Operation Website:**

**Web:** [www.yishengtec.cn/en](http://www.yishengtec.cn/en)

**Office Address:**

**Shenzhen Headquarters:** 6/F, R&D Center, Lixinhu High-tech Industrial Park, Bao'an District, Shenzhen

**Guangzhou Branch:** Room 318, Jiangrun Building, No. 565, Xingnan Avenue, Panyu District, Guangzhou

*Looking forward to working with you, thank you*